

# 添付資料4 弓田交差点交通量調査結果

(調査日 平成28年7月9日(土), 14日(木))

① 至 (仮)旧青果市場北交差点

至 (仮)旧青果市場南交差点 ④ ② 至 坂付団地交差点

## 交通量調査集計表(流入・流出・断面交通量)

交差点名: 弓田交差点

流入部①: 至 (仮)旧青果市場北交差点

調査日: 平成28年7月9日(土曜日)

時間帯	流入				流出				断面																		
	乗用車		貨物車		乗用車		貨物車		乗用車		貨物車		乗用車														
	乗用車	バス	小型貨物	普通貨物	乗用車	バス	小型貨物	普通貨物	乗用車	バス	小型貨物	普通貨物	乗用車	バス													
07:00~07:15	56	1	17	5	79	73	6	120	32	4	157	152	5	3.2	10	176	2	49	9	236	225	11	4.7	14			
07:15~07:30	73	1	18	10	102	91	11	148	2	40	202	188	14	6.9	11	221	3	58	22	304	279	25	8.2	16			
07:30~07:45	96	2	14	8	120	110	10	147	1	41	194	188	6	3.1	12	243	3	55	13	314	298	16	5.1	16			
07:45~08:00	95	0	26	7	128	121	7	196	3	29	233	225	8	3.4	18	291	3	55	12	361	346	15	4.2	21			
08:00~08:15	109	2	9	11	131	118	13	182	1	28	220	210	10	4.5	13	291	3	57	20	351	328	23	6.6	16			
08:15~08:30	120	1	24	7	152	144	8	180	4	44	241	224	17	7.1	14	300	5	68	20	393	368	25	6.4	20			
08:30~08:45	134	1	27	14	176	161	15	190	2	39	246	229	17	6.9	19	324	3	66	29	422	390	32	7.6	22			
08:45~09:00	137	1	30	8	176	167	9	167	1	26	203	193	10	4.9	8	304	2	56	17	379	360	19	5.0	13			
09:00~09:15	130	0	32	13	175	162	13	207	2	32	249	239	10	4.0	4	337	3	64	21	424	401	23	5.4	8			
09:15~09:30	131	2	36	14	183	167	16	197	1	26	237	223	14	5.9	9	328	3	62	27	420	390	30	7.1	13			
09:30~09:45	145	2	32	10	189	177	12	222	1	30	264	252	12	4.5	7	367	3	62	21	453	429	24	5.3	12			
09:45~10:00	151	2	24	10	187	175	12	221	1	20	250	241	9	3.6	7	372	3	44	18	437	416	21	4.8	14			
朝ピーク3時間計	1,377	15	289	117	1,798	1,666	132	2,177	20	387	1,12	2,696	2,584	132	4.9	132	3,554	35	676	229	4,494	4,230	264	5.9	185		
10:00~10:15	124	0	26	15	165	150	15	209	2	25	12	248	234	14	5.6	6	333	2	51	27	413	384	29	7.0	8		
10:15~10:30	143	2	36	10	191	179	12	211	1	33	11	256	244	12	4.7	14	354	3	69	21	447	423	24	5.4	15		
10:30~10:45	149	1	29	15	194	178	16	204	2	26	10	242	230	12	5.0	14	353	3	55	25	436	408	28	6.4	23		
10:45~11:00	192	3	28	12	235	220	15	197	2	28	11	238	225	13	5.5	7	389	5	56	23	473	445	28	5.9	12		
11:00~11:15	149	0	25	14	188	174	14	223	2	24	6	235	247	8	3.1	5	372	2	49	20	443	421	22	5.0	11		
11:15~11:30	166	4	22	7	199	188	11	211	3	24	5	271	263	8	3.0	4	405	7	46	12	470	451	19	4.0	10		
11:30~11:45	193	3	18	6	220	211	9	191	2	19	13	225	210	15	6.7	15	384	5	37	19	445	421	24	5.4	22		
11:45~12:00	169	0	33	13	215	202	13	198	0	32	9	239	230	9	3.8	6	367	0	65	22	454	432	22	4.8	11		
12:00~12:15	167	2	23	11	203	190	13	168	2	31	14	215	199	16	7.4	6	335	4	54	25	418	389	29	6.9	12		
12:15~12:30	202	1	44	4	251	246	5	204	2	24	5	235	228	7	3.0	8	406	3	68	9	486	474	12	2.9	20		
12:30~12:45	187	1	26	1	215	213	2	190	1	25	5	221	215	6	2.7	8	377	2	51	6	436	428	8	1.8	17		
12:45~13:00	185	0	22	7	214	207	7	204	1	23	11	237	224	13	5.5	12	386	2	45	18	451	431	20	4.4	22		
13:00~13:15	209	3	24	6	242	233	9	227	1	21	7	256	248	8	3.1	12	436	4	45	13	498	481	17	3.4	20		
13:15~13:30	183	0	24	6	213	207	6	214	3	25	8	250	239	11	4.4	8	397	3	49	14	463	446	17	3.7	16		
13:30~13:45	176	1	35	11	223	211	12	216	0	18	3	237	224	3	1.3	9	392	1	53	14	460	445	15	3.3	17		
13:45~14:00	172	0	28	7	207	200	7	184	1	23	7	215	207	8	3.7	8	356	1	51	14	422	407	15	3.6	20		
14:00~14:15	172	0	28	7	207	200	7	184	1	23	7	215	207	8	3.7	8	356	1	51	14	422	407	15	3.6	20		
14:15~14:30	177	3	20	12	212	197	15	171	6	208	2	35	6	251	243	8	3.2	12	385	5	55	18	463	440	23	5.0	18
14:30~14:45	183	0	23	4	210	206	4	156	1	20	10	187	176	11	5.9	7	339	1	43	14	397	382	15	3.8	13		
14:45~15:00	209	2	29	7	247	238	9	215	1	27	9	252	242	10	4.0	8	424	3	56	16	499	480	19	3.8	15		
15:00~15:15	195	1	20	10	226	215	11	176	1	22	8	202	193	9	4.5	8	366	2	42	18	428	408	20	4.7	26		
15:15~15:30	183	2	27	7	219	210	9	160	1	14	6	181	174	7	3.9	8	343	3	41	13	400	384	16	4.0	18		
15:30~15:45	206	3	27	11	247	233	14	189	1	24	9	223	213	10	4.5	14	395	4	51	20	470	446	24	5.1	31		
15:45~16:00	235	1	18	3	257	253	4	152	1	18	7	178	170	8	4.5	3	387	2	36	10	435	423	12	2.8	12		
オフピーク6時間計	4,366	36	634	209	5,245	5,000	245	4,771	198	4,731	36	5,586	5,317	235	4.2	208	9,097	72	1,220	408	10,797	10,317	480	4.4	406		
16:00~16:15	206	2	22	14	244	228	16	66	17	176	2	33	9	220	209	11	5.0	11	382	4	55	23	464	437	27	5.8	28
16:15~16:30	214	2	21	9	246	235	11	189	1	21	1	212	210	2	0.9	7	403	3	42	10	458	445	13	2.8	19		
16:30~16:45	189	3	31	3	226	220	6	177	1	15	3	196	192	4	2.0	7	366	4	46	6	422	412	10	2.4	16		
16:45~17:00	233	4	22	2	261	255	6	23	11	169	2	190	186	4	2.1	10	402	6	39	4	451	441	10	2.2	21		
17:00~17:15	237	2	33	3	275	270	5	187	2	26	5	231	224	7	3.0	7	435	4	59	8	506	494	12	2.4	14		
17:15~17:30	270	1	30	4	302	300	2	140	1	18	2	167	158	3	1.9	9	410	2	48	3	463	458	5	1.1	29		
17:30~17:45	266	4	33	4	307	299	8	185	1	17	4	201	202	5	2.4	11	451	5	50	8	514	501	13	2.5	30		
17:45~18:00	218	1	23	1	243	241	2	166	1	16	1	184	182	2	1.1	6	384	2	39	2	427	423	4	0.9	16		
18:00~18:15	237	1	39	0	277	276	1	164	1	17	3	185	181	4	2.2	6	401	2	56	3	462	457	5	1.1	15		
18:15~18:30	242	1	31	0	274	273	1	144	1	14	1	204	199	5	2.5	6	427	5	45	4	478	472	6	1.3	20		
18:30~18:45	268	3	26	3	300	294	6	20	18	183	2	20	3	208	203	5	2.4	12	451	5	46	508	497	11	2.2	30	
18:45~19:00	195	1	14	3	213	209	4	197	169	2	1	183	180	3	1.6	8	364	3	25	4	396	389	7	1.8	25		
夕ピーク3時間計	2,775	25	325	43	3,168	3,100	68	2,163	201	20	225	35	2,381	2,326	55	23	100	4,876	45	550	78						

① 至 (仮)旧青果市場北交差点

至 (仮)旧青果市場南交差点 ④ ② 至 板付団地交差点

③ 至 諸岡丁目交差点

交通調査集計表(流入・流出・断面交通量)

Table with columns for direction (流入, 流出, 断面), time period (時間帯), and various vehicle types (乗用車, 小型車, 大型車, etc.). Includes a summary row for '朝ピーク3時間計' and '夕ピーク6時間計'.

調査日:平成28年7月9日(土曜日)



① 至 (仮)旧青果市場北交差点

至 (仮)旧青果市場南交差点 ④

② 至 板付団地交差点

交通量調査集計表(流入・流出・断面交通量)

③ 至 諸岡丁目交差点

Table with columns for direction (流入部, 断面, 流出部), time intervals, and various traffic volume metrics (乗用車, 小型車, 大型車, 貨物車, etc.). Includes a summary row at the bottom.

調査日:平成28年7月9日(土曜日)

流入部③: 至 諸岡丁目交差点

① 至 (仮)旧青果市場北交差点

至 (仮)旧青果市場南交差点 ④ ② 至 振付団地交差点

③ 至 諸岡丁目交差点

交通量調査集計表(流入・流出・断面交通量)

流入部④: 至 (仮)旧青果市場南交差点

調査日:平成28年7月9日(土曜日)

Table with columns for direction (方向別), time period (時間帯), and traffic volume (交通量) categorized by vehicle type (乗用車, 貨物車, etc.) and count (計). Includes sub-sections for '流入' (Inflow) and '断面' (Cross-section).

Summary table for the '断面' section, showing total counts for various vehicle types across different time periods.



① 至 (仮)旧青果市場北交差点

至 (仮)旧青果市場南交差点 ④ ② 至 板付団地交差点

交通量調査集計表(総流入出交通量)

③ 至 諸岡1丁目交差点

交差点名：弓田交差点

調査日：平成28年7月9日(土曜日)

時間帯	総 流 入 計									
	乗用車類		貨物車類		自動車 類計	小型車 計	大型車 計	大型車 混入率	バイク	自動車類計 時間比率
	乗用車	バス	小型貨物	普通貨物						
07:00~07:15	396	3	106	23	528	502	26	4.9	27	6.1
07:15~07:30	415	6	126	37	584	541	43	7.4	29	6.7
07:30~07:45	484	3	105	29	621	589	32	5.2	36	7.2
07:45~08:00	527	4	114	23	668	641	27	4.0	44	7.7
08:00~08:15	553	6	117	56	732	670	62	8.5	35	8.4
08:15~08:30	572	6	148	49	775	720	55	7.1	33	8.9
08:30~08:45	591	4	132	57	784	723	61	7.8	35	9.0
08:45~09:00	573	2	115	55	745	688	57	7.7	26	8.6
09:00~09:15	609	4	125	53	791	734	57	7.2	19	9.1
09:15~09:30	612	8	137	56	813	749	64	7.9	25	9.4
09:30~09:45	667	4	127	50	848	794	54	6.4	22	9.8
09:45~10:00	641	5	99	41	786	740	46	5.9	25	9.1
朝ピーク 3時間計	6,640	55	1,451	529	8,675	8,091	584	6.7	356	90.9
10:00~10:15	674	4	132	59	869	806	63	7.2	21	4.2
10:15~10:30	615	8	123	51	797	738	59	7.4	22	3.9
10:30~10:45	657	5	102	48	812	759	53	6.5	34	3.9
10:45~11:00	736	7	106	56	905	842	63	7.0	22	4.4
11:00~11:15	702	4	103	47	856	805	51	6.0	22	4.2
11:15~11:30	723	8	98	30	859	821	38	4.4	19	4.2
11:30~11:45	751	6	97	51	905	848	57	6.3	33	4.4
11:45~12:00	657	2	104	46	809	761	48	5.9	20	3.9
12:00~12:15	628	6	114	49	797	742	55	6.9	25	3.9
12:15~12:30	716	4	112	32	864	828	36	4.2	32	4.2
12:30~12:45	760	3	100	31	894	860	34	3.8	33	4.3
12:45~13:00	701	4	98	35	838	799	39	4.7	34	4.1
13:00~13:15	727	6	92	28	853	819	34	4.0	35	4.1
13:15~13:30	717	5	115	38	875	832	43	4.9	29	4.2
13:30~13:45	750	3	96	37	886	846	40	4.5	27	4.3
13:45~14:00	745	6	110	32	893	855	38	4.3	30	4.3
14:00~14:15	679	4	105	34	822	784	38	4.6	26	4.0
14:15~14:30	690	8	112	40	850	802	48	5.6	27	4.1
14:30~14:45	713	5	112	45	875	825	50	5.7	35	4.2
14:45~15:00	753	4	143	32	932	896	36	3.9	29	4.5
15:00~15:15	711	6	104	39	860	815	45	5.2	43	4.2
15:15~15:30	681	5	87	34	807	768	39	4.8	28	3.9
15:30~15:45	742	6	87	44	879	829	50	5.7	41	4.3
15:45~16:00	751	5	85	41	882	836	46	5.2	26	4.3
オフピーク 6時間計	16,979	124	2,537	979	20,619	19,516	1,103	5.3	693	95.7
16:00~16:15	711	7	104	41	863	815	48	5.6	42	8.1
16:15~16:30	692	3	94	28	817	786	31	3.8	31	7.7
16:30~16:45	739	7	100	23	869	839	30	3.5	28	8.2
16:45~17:00	778	7	89	22	896	867	29	3.2	34	8.4
17:00~17:15	811	5	114	22	952	925	27	2.8	32	8.9
17:15~17:30	760	4	101	18	883	861	22	2.5	53	8.3
17:30~17:45	804	5	96	20	925	900	25	2.7	61	8.7
17:45~18:00	798	5	101	11	915	899	16	1.7	42	8.6
18:00~18:15	787	5	98	12	902	885	17	1.9	31	8.5
18:15~18:30	816	6	96	13	931	912	19	2.0	47	8.7
18:30~18:45	808	6	85	14	913	893	20	2.2	43	8.6
18:45~19:00	711	4	64	6	785	775	10	1.3	41	7.4
夕ピーク 3時間計	9,215	64	1,142	230	10,651	10,357	294	2.8	485	92.7
12時間計	32,834	243	5,130	1,738	39,945	37,964	1,981	5.0	1,534	100



歩行者類交通量

交差点名：弓田交差点

調査日：#####

時間帯	あーい		いーう		うーい		いーえ		えーう		あーえ		総利用者															
	歩行者	自転車	歩行者	自転車	歩行者	自転車	歩行者	自転車	歩行者	自転車	歩行者	自転車	歩行者	自転車	合計													
07:00~07:15	0	13	0	2	1	7	8	1	2	3	1	8	9	1	2	2	18	20										
07:15~07:30	0	5	0	1	1	3	4	1	2	3	0	5	5	0	2	2	0	13	13									
07:30~07:45	3	10	2	5	1	7	8	1	4	5	4	9	13	1	3	4	7	9	22	31								
07:45~08:00	2	6	8	1	7	8	11	2	8	10	3	3	4	7	0	3	3	19	22	31								
08:00~08:15	9	15	24	5	10	1	5	6	4	9	13	1	10	11	0	3	3	4	7	17	27	44						
08:15~08:30	3	15	18	1	5	6	3	9	4	15	19	2	3	5	8	2	5	7	1	2	3	7	27	34				
08:30~08:45	8	13	21	0	5	5	6	8	14	1	15	16	1	3	4	0	4	1	2	3	9	24	33					
08:45~09:00	3	14	17	2	6	8	6	9	15	5	7	12	2	1	3	5	7	1	4	5	8	29	37					
09:00~09:15	0	10	10	2	6	8	1	4	5	4	2	6	0	12	12	0	5	5	0	2	2	2	23	25				
09:15~09:30	4	12	16	4	7	11	5	6	11	6	9	15	1	9	10	0	1	1	0	1	1	8	21	29				
09:30~09:45	6	6	12	4	6	10	10	8	18	5	12	17	3	6	10	3	5	8	0	5	13	22	35					
09:45~10:00	6	18	24	3	2	5	8	7	15	5	6	11	4	6	0	9	9	1	1	1	1	8	21	29				
朝ピーク 3時間計	44	137	181	24	57	81	54	70	124	36	102	138	21	29	50	27	84	111	9	50	59	13	37	10	12	36	48	
10:00~10:15	7	11	18	2	2	4	10	6	16	6	9	15	3	3	6	2	11	13	4	3	7	2	5	7	15	21	36	
10:15~10:30	6	4	10	3	4	7	10	13	23	3	9	12	1	6	7	2	4	6	1	2	3	4	2	6	14	12	26	
10:30~10:45	0	6	6	4	10	14	6	6	12	6	14	20	6	12	5	7	12	1	4	5	1	5	6	6	14	12	26	
10:45~11:00	4	7	11	9	3	12	5	8	13	8	7	15	2	5	7	2	6	8	0	3	3	3	1	4	16	14	30	
11:00~11:15	3	13	16	2	9	11	4	4	8	9	9	18	0	3	3	1	6	7	2	0	2	1	8	9	8	30	38	
11:15~11:30	2	10	12	4	12	16	8	7	15	4	9	13	2	12	14	4	6	10	2	8	10	3	6	9	11	36	47	
11:30~11:45	2	6	8	2	11	13	7	4	11	8	10	18	4	13	17	4	7	11	0	4	4	1	2	3	5	23	28	
11:45~12:00	3	10	13	1	7	8	7	6	13	11	6	17	1	4	5	1	7	8	1	5	6	1	4	5	6	26	32	
12:00~12:15	2	8	10	4	7	11	3	10	13	1	8	9	0	3	3	0	6	6	0	0	0	7	7	6	22	28	32	
12:15~12:30	5	6	11	7	6	13	7	8	15	8	13	21	2	7	9	5	6	11	1	5	6	1	2	3	14	19	33	
12:30~12:45	6	11	17	4	9	13	6	9	15	7	8	15	2	1	3	3	6	9	1	4	5	2	7	9	13	31	44	
12:45~13:00	4	4	8	9	7	16	4	7	11	7	16	23	1	6	7	1	11	12	1	1	2	1	5	6	15	17	32	
13:00~13:15	5	16	21	4	12	16	4	2	6	5	7	12	1	6	7	1	2	0	0	2	2	0	6	6	9	36	45	
13:15~13:30	6	10	16	11	4	15	6	9	15	9	12	1	5	7	12	2	2	4	1	5	6	1	5	6	19	24	43	
13:30~13:45	4	9	13	8	0	8	14	8	22	6	9	15	4	6	10	3	5	8	3	6	9	1	1	2	16	16	32	
13:45~14:00	2	9	11	7	2	9	8	12	20	10	6	16	0	6	6	2	1	3	1	2	3	2	3	5	12	16	28	
14:00~14:15	3	12	15	4	10	14	2	4	6	4	4	8	0	5	5	1	3	4	3	10	13	0	5	5	10	37	47	
14:15~14:30	10	7	17	0	6	6	3	5	8	5	5	10	3	5	8	3	3	6	2	5	7	0	3	3	12	21	33	
14:30~14:45	5	8	13	4	9	13	1	5	6	4	4	8	1	5	6	5	5	10	2	4	3	4	3	4	7	14	23	37
14:45~15:00	1	6	7	1	13	14	4	10	14	3	5	8	4	5	9	1	2	0	0	0	1	3	4	7	14	23	37	
15:00~15:15	0	10	10	1	4	5	9	7	16	3	8	11	6	7	13	2	7	9	3	3	6	0	3	3	4	20	24	
15:15~15:30	1	12	13	9	11	20	2	11	13	2	9	11	1	7	8	0	1	1	0	4	4	1	7	8	11	34	45	
15:30~15:45	4	15	19	4	5	9	7	10	17	3	11	14	5	9	14	0	10	10	2	3	5	1	3	4	11	26	37	
15:45~16:00	4	8	12	4	5	9	4	6	10	1	10	11	1	14	15	0	4	4	3	4	7	1	3	4	12	20	32	
オフピーク 6時間計	89	218	307	108	168	276	141	177	318	133	208	341	55	151	206	50	131	181	84	85	119	31	100	131	262	571	833	
16:00~16:15	2	7	9	1	10	11	3	15	18	4	9	13	0	5	5	1	0	1	0	0	1	0	1	0	1	4	17	21
16:15~16:30	3	13	16	1	9	10	3	7	10	3	5	8	2	6	8	1	5	6	1	2	3	1	8	9	6	32	38	
16:30~16:45	3	13	16	3	10	13	18	12	30	8	7	15	7	13	20	3	2	5	3	2	5	6	6	12	15	31	46	
16:45~17:00	0	7	7	8	2	10	6	11	17	3	9	12	2	15	17	2	9	11	1	5	6	3	1	4	12	15	27	
17:00~17:15	1	11	12	10	5	15	1	13	14	4	12	16	0	12	12	0	4	4	0	3	3	2	4	6	13	23	36	
17:15~17:30	3	10	13	6	13	19	15	16	31	5	11	16	3	13	16	2	6	8	0	0	0	3	9	26	35			
17:30~17:45	1	11	12	5	18	23	5	22	27	4	16	20	2	14	16	3	8	11	1	4	5	7	9	16	14	42	56	
17:45~18:00	1	3	4	3	8	11	6	14	20	15	13	28	2	11	13	3	3	6	0	3	3	1	7	8	5	21	26	
18:00~18:15	1	4	5	6	7	13	9	19	28	8	10	18	1	8	9	5	7	12	0	0	0	6	2	8	13	13	26	
18:15~18:30	5	8	13	0	15	15	6	7	13	9	10	19	6	10	16	1	5	6	2	4	1	7	8	8	32	40	49	
18:30~18:45	3	10	13	3	9	12	12	19	31	9	8	17	6	10	16	2	5	7	1	7	8	3	6	9	10	32	42	
18:45~19:00	4	5	9	9	14	23	6	13	19	5	8	13	1	14	15	1	6	7	2	2	4	5	9	14	20	30	50	
夕ピーク 3時間計	27	102	129	55	120	175	90	168	258	77	118	195	32	131	163	24	60	84	11	30	41	36	62	98	129	314	443	
12時間計	160	457	617	187	345	532	285	415	700	246	428	674	108	311	419	101	275	376	54	165	219	80	199	279	481	1166	1647	

弓田交差点  
H28.7.9(土)

① 至 (仮)旧青果市場北交差点

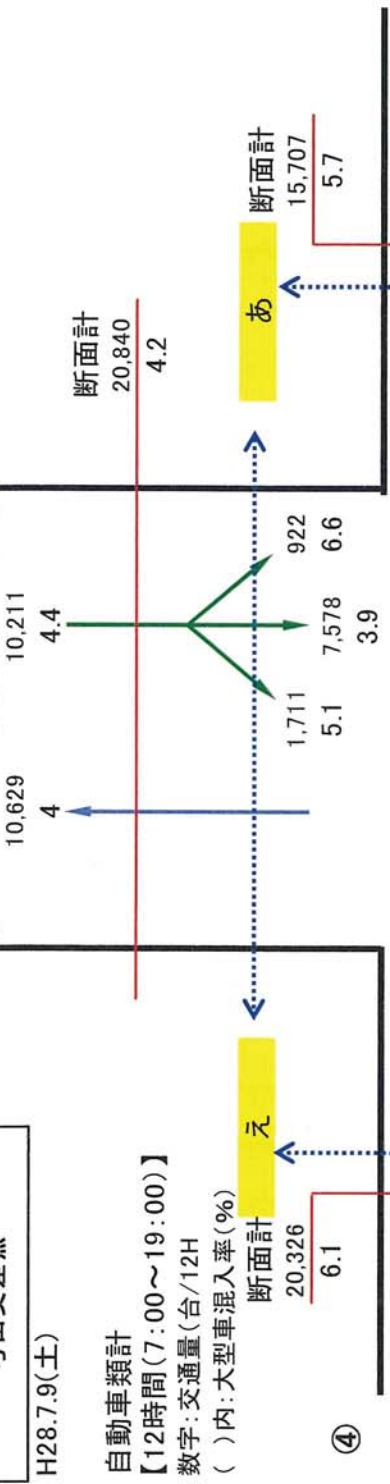

自動車種類計  
【12時間(7:00~19:00)】  
数字:交通量(台/12H)  
( )内:大型車混入率(%)

④ 至 (仮)旧青果市場南交差点

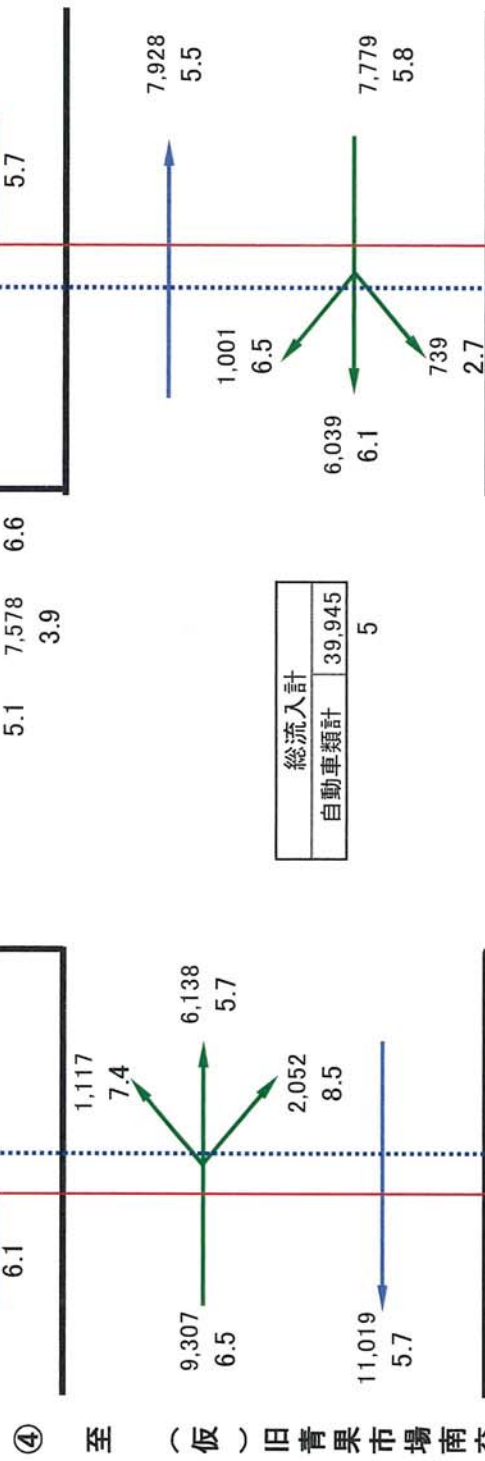

② 至 板付団地交差点

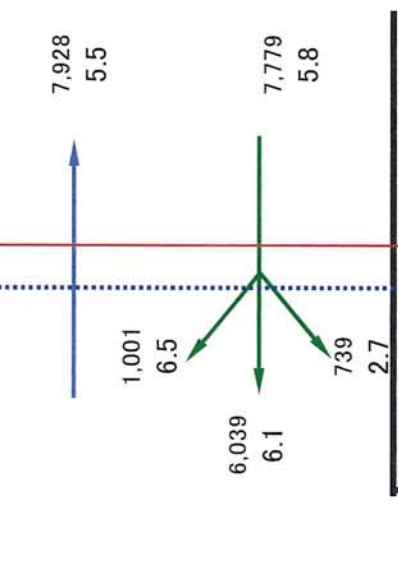

③ 至 諸岡1丁目交差点

断面計  
23,017  
4.2

断面計  
15,707  
5.7

断面計  
23,017  
4.2

総流入計	39,945
自動車種類計	5

あ⇐い 1,149  
い⇐う 1,374  
う⇐え 795  
え⇐あ 498  
総利用者 3,816

単位: (人・台/12H)



**流入部別交通量**

交差点名: 弓田交差点

調査日: H28.07.09(土)

**総流入交通量**

**弓田交差点総流入交通量**

時間帯	小型車 交通量	大型車 交通量	大型車 混入率
7	2273	128	5.3%
8	2801	235	7.7%
9	3017	221	6.8%
10	3145	238	7.0%
11	3235	194	5.7%
12	3229	164	4.8%
13	3352	155	4.4%
14	3307	172	4.9%
15	3248	180	5.3%
16	3307	138	4.0%
17	3585	90	2.4%
18	3465	66	1.9%
12時間計	37964	1981	5.0%

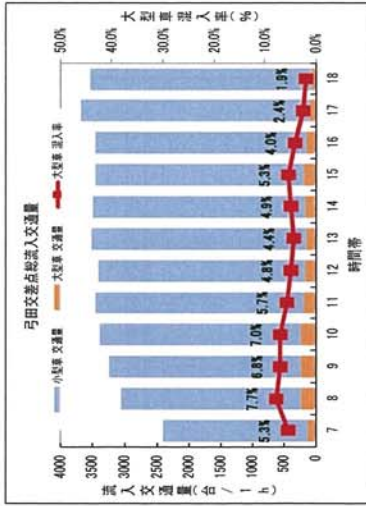

弓田交差点

車種	台数	構成比
乗用車	32,834	78.3%
バス	243	0.6%
小型貨物	5,130	12.2%
普通貨物	1,738	4.1%
大型車計	1,981	4.7%
自動車計	41,926	100.0%

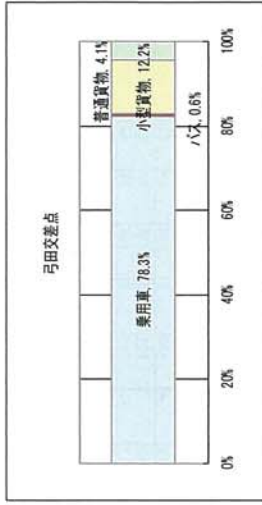

**流入部①:至(仮)旧青葉市場北交差点**

時間帯	小型車 交通量	大型車 交通量	大型車 混入率
7	395	34	7.9%
8	590	45	7.1%
9	681	53	7.2%
10	727	58	7.4%
11	775	47	5.7%
12	856	27	3.1%
13	890	40	4.3%
14	841	35	4.0%
15	911	38	4.0%
16	938	39	4.0%
17	1110	17	1.5%
18	1052	12	1.1%
12時間計	9766	445	4.4%

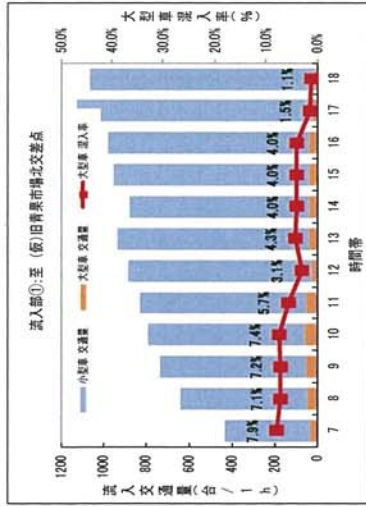

**流入部③:至 諸岡丁日交差点**

時間帯	小型車 交通量	大型車 交通量	大型車 混入率
7	783	31	3.8%
8	984	62	5.9%
9	1106	56	4.8%
10	1093	62	5.4%
11	1104	44	3.8%
12	998	42	4.0%
13	1095	32	2.8%
14	1063	34	3.1%
15	972	35	3.5%
16	1011	29	2.8%
17	995	22	2.2%
18	969	26	2.6%
12時間計	12173	475	3.8%

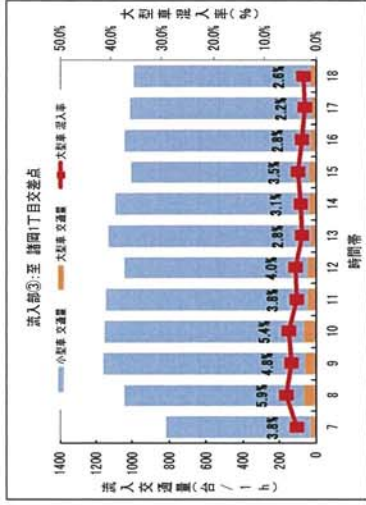

**流入部②:至 板付団地交差点**

時間帯	小型車 交通量	大型車 交通量	大型車 混入率
7	428	25	5.5%
8	534	64	10.7%
9	539	53	9.0%
10	549	50	8.3%
11	597	36	5.7%
12	641	37	5.5%
13	829	42	6.3%
14	634	38	5.7%
15	670	48	6.7%
16	652	26	3.8%
17	716	24	3.2%
18	738	9	1.2%
12時間計	7327	452	5.8%

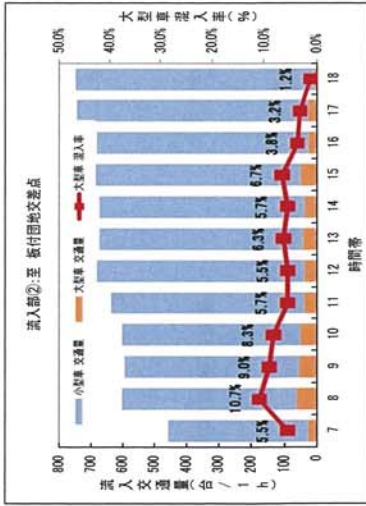

**流入部④:至(仮)旧青葉市場南交差点**

時間帯	小型車 交通量	大型車 交通量	大型車 混入率
7	667	38	5.4%
8	693	64	8.5%
9	691	59	7.9%
10	776	68	8.1%
11	759	67	8.1%
12	734	58	7.3%
13	738	41	5.3%
14	769	65	7.8%
15	695	59	7.8%
16	706	44	5.9%
17	764	27	3.4%
18	706	19	2.6%
12時間計	8698	609	6.5%

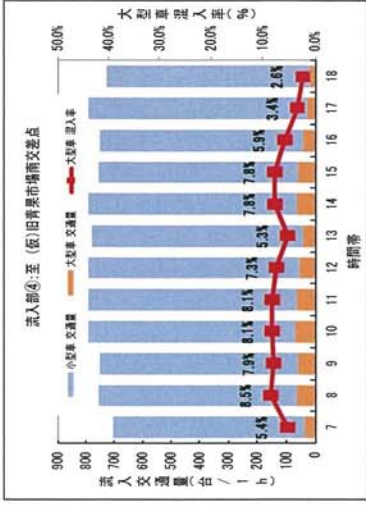



①至 (仮)旧青果市場北交差点

至 (仮)旧青果市場南交差点④ ②至 坂付団地交差点

③至 踏門丁交差点

交通量調査集計表(流入・流出・断面交通量)

交差点名: 弓田交差点

流入部①: 至 (仮)旧青果市場北交差点

調査日: 平成28年7月14日(木曜日)

Table with columns for direction (流入, 流出, 断面) and vehicle type (乗用車, 小型貨物, 普通貨物, 大型車, 混入車, バイク). Rows represent time intervals from 07:00 to 18:00, plus 6-minute and 12-minute totals.

① 至 (仮)旧青果市場南交差点

至 (仮)旧青果市場南交差点④ ② 至 板付団地交差点

③ 至 諸岡丁目交差点

交通調査集計表(流入・流出・断面交通量)

Table with columns for direction, time period, and various vehicle categories (passenger cars, buses, motorcycles, etc.) under 'Inflow', 'Outflow', and 'Cross-section' sections. Includes a survey date of July 14, 2028.





交通量調査集計表(流入・流出・断面交通量)

調査日:平成28年7月14日(木曜日)

流入部③: 至 諸岡1丁目交差点

時間帯 方向別	流入					流出					断面																
	乗用車 バス	貨物車種 小型貨物 普通貨物	自動車 種別計	大型車 計	大型車 流入車	乗用車種 バス	貨物車種 小型貨物 普通貨物	自動車 種別計	大型車 計	大型車 流入車	乗用車種 バス	貨物車種 小型貨物 普通貨物	自動車 種別計	大型車 計	大型車 流入車												
07:00~07:15	291	2	56	7	358	349	9	2.5	19	116	0	29	11	156	145	11	7.1	8	407	2	87	18	514	494	20	3.9	27
07:15~07:30	320	2	57	3	382	377	5	1.3	22	136	1	25	7	169	161	8	4.7	11	456	3	82	10	551	538	13	2.4	33
07:30~07:45	300	3	40	10	353	340	13	3.7	25	136	1	22	9	168	158	10	6.0	7	436	4	67	19	521	498	23	4.4	32
07:45~08:00	286	2	61	9	358	347	11	3.1	21	149	1	26	4	180	175	5	2.8	12	435	3	87	13	538	522	16	3.0	33
08:00~08:15	293	2	54	19	368	347	21	5.7	36	148	2	43	13	206	191	15	7.3	5	441	4	97	32	574	538	36	6.3	41
08:15~08:30	227	5	42	10	284	269	15	5.3	23	141	2	41	16	200	182	18	9.0	12	368	7	83	26	484	451	33	6.8	35
08:30~08:45	248	3	51	7	309	299	10	3.2	27	148	2	48	9	207	196	11	5.3	8	396	5	99	16	516	495	21	4.1	35
08:45~09:00	169	2	47	20	238	216	22	9.2	15	108	1	38	16	163	146	17	10.4	7	277	3	85	36	401	362	39	9.7	22
09:00~09:15	222	3	47	16	288	269	19	6.6	14	134	4	48	12	198	182	16	8.1	4	356	7	95	28	486	451	35	7.2	18
09:15~09:30	194	7	53	18	272	247	25	9.2	18	157	2	57	17	233	214	19	8.2	12	351	9	110	35	505	461	44	8.7	30
09:30~09:45	197	1	44	13	255	241	14	5.5	11	131	1	49	23	204	180	24	11.8	3	328	2	93	36	459	421	38	8.3	14
09:45~10:00	186	1	52	14	253	248	15	5.7	14	144	2	59	20	225	203	22	9.8	10	340	3	111	34	488	451	37	7.6	16
朝ピーク 3時間計	2,943	33	606	146	3,728	3,549	179	4.8	237	1,648	19	485	157	2,309	2,133	176	7.6	99	4,591	52	1,091	303	6,037	5,692	355	5.9	336
10:00~10:15	178	4	67	9	258	245	13	5.0	16	183	5	73	23	284	256	28	9.9	4	361	9	140	32	542	501	41	7.6	20
10:15~10:30	182	5	68	13	268	250	18	6.7	7	129	1	50	13	193	179	14	7.3	5	311	6	118	26	461	429	32	6.9	12
10:30~10:45	176	4	50	18	248	226	22	8.9	8	132	2	58	15	207	190	17	8.2	8	308	6	108	33	455	416	39	8.6	16
10:45~11:00	177	1	64	19	261	241	20	7.7	7	189	1	55	16	261	244	17	6.5	7	366	2	119	35	522	485	37	7.1	14
11:00~11:15	177	5	65	15	262	242	20	7.6	11	147	5	53	14	219	200	19	8.7	3	324	2	118	29	481	442	39	8.1	14
11:15~11:30	148	2	52	13	215	200	15	7.0	10	182	0	60	18	260	242	18	6.9	5	330	2	112	31	475	442	33	6.9	15
11:30~11:45	188	4	53	6	251	241	10	4.0	12	170	3	73	20	266	243	23	8.6	8	358	7	126	26	517	464	53	6.4	20
11:45~12:00	163	4	39	9	215	202	13	6.0	5	162	2	66	10	240	228	12	5.0	2	325	6	105	19	455	430	25	5.5	7
12:00~12:15	200	1	39	15	255	239	16	6.3	14	206	3	59	14	282	265	17	6.0	11	406	4	98	29	537	504	33	6.1	25
12:15~12:30	188	5	41	8	232	239	13	5.2	9	156	1	43	13	213	199	14	6.6	10	354	6	84	21	465	438	27	5.8	19
12:30~12:45	185	2	36	4	227	221	6	2.6	6	167	2	56	11	236	223	13	5.5	5	352	4	92	15	463	444	19	4.1	11
13:00~13:15	174	2	38	7	221	212	9	4.1	15	167	3	54	8	232	221	11	4.7	9	341	5	92	15	453	433	20	4.4	24
13:15~13:30	184	2	52	19	257	236	21	8.2	13	155	2	46	16	219	201	18	8.2	11	339	4	98	35	476	437	39	8.2	24
13:30~13:45	175	3	50	8	236	225	11	4.7	7	172	2	49	10	233	221	12	5.2	4	347	5	99	18	469	446	23	4.9	11
13:45~14:00	179	2	36	7	224	215	9	4.0	10	146	1	57	17	221	203	18	8.1	7	325	3	93	24	445	418	27	6.1	17
14:00~14:15	157	1	44	7	209	201	8	3.8	5	165	3	58	18	244	223	21	8.6	5	322	4	102	25	453	424	29	6.4	10
14:15~14:30	217	3	62	16	298	279	19	6.4	6	158	1	58	9	226	216	10	4.4	4	375	4	120	25	524	495	29	5.5	10
14:30~14:45	210	2	51	9	272	261	11	4.0	7	233	5	54	25	317	287	30	9.5	9	443	7	105	34	589	548	41	7.0	16
14:45~15:00	180	5	56	7	248	236	12	4.8	11	140	2	35	13	190	175	15	7.9	17	320	7	91	20	438	411	27	6.2	28
15:00~15:15	183	1	52	6	242	235	7	2.9	12	191	1	23	10	225	214	11	4.9	6	374	2	75	16	467	449	18	3.9	18
15:15~15:30	186	3	52	15	256	238	18	7.0	8	184	1	50	11	246	234	12	4.9	7	370	4	102	26	502	472	30	6.0	15
15:30~15:45	187	2	48	6	243	235	8	3.3	14	192	3	43	10	248	235	13	5.2	12	379	5	91	16	491	470	21	4.3	26
15:45~16:00	203	9	56	19	287	269	28	9.8	10	192	2	40	10	244	232	12	4.9	6	395	11	96	29	531	491	40	7.5	16
オフピーク 6時間計	4,402	75	1,209	265	5,951	5,611	340	5.7	230	4,100	52	1,259	331	5,742	5,399	383	6.7	168	8,502	127	2,468	596	11,693	10,970	723	6.2	398
16:00~16:15	178	1	60	9	248	238	10	4.0	9	187	4	49	7	247	236	11	4.5	7	365	5	109	16	495	474	21	4.2	16
16:15~16:30	179	5	56	6	246	235	11	4.5	8	151	0	24	3	178	175	3	1.7	6	330	5	80	9	424	410	14	3.3	14
16:30~16:45	146	4	61	4	215	207	8	3.7	11	180	2	25	4	211	205	6	2.8	7	326	6	86	8	426	412	14	3.3	18
16:45~17:00	232	5	77	7	321	309	12	3.7	4	174	3	35	3	215	209	6	2.8	11	406	8	112	10	536	518	18	3.4	15
17:00~17:15	196	2	50	6	254	246	8	3.1	14	210	4	47	6	267	257	10	3.7	7	406	6	97	12	521	503	18	3.5	21
17:15~17:30	176	3	56	4	239	232	7	2.9	26	206	2	46	4	258	252	6	2.3	18	382	5	102	8	487	484	13	2.6	44
17:30~17:45	217	2	61	6	286	278	8	2.8	11	232	1	42	2	277	274	3	1.1	28	449	3	103	8	583	552	11	2.0	39
17:45~18:00	209	4	44	9	266	253	13	4.9	13	256	1	35	13	305	291	14	4.6	23	465	5	79	22	544	527	17	4.7	36
18:00~18:15	243	1	44	6	294	287	7	2.4	11	237	1	48	3	289	295	4	1.4	22	480	2	92	9	583	572	11	1.9	33
18:15~18:30	226	4	41	5	276	267	9	3.3	7	228	2	36	8	274	264	10	3.6	16	454	6	77	13	550	531	19	3.5	25
18:30~18:45	226	1	37	5	269	263	6	2.2	9	280	1	38	3	322	318												

① 至 (仮)旧青果市場北交差点

至 (仮)旧青果市場南交差点 ④ ② 至 坂付団地交差点

交通量調査集計表(流入・流出・断面交通量)

③ 至 踏間丁目交差点

流入部④: 至 (仮)旧青果市場南交差点

調査日:平成28年7月14日(木曜日)

Table with columns for direction (方向別), time period (時間帯), and flow types (流入, 流出, 断面). It includes sub-columns for vehicle types (乗用車, 小型車, 大型車, 混入車) and modes (バス, ハイク, バイク). Rows list time intervals from 07:00 to 18:00, plus 3-hour and 6-hour totals.



① 至 (仮)旧青果市場北交差点

至 (仮)旧青果市場南交差点 ④

② 至 板付団地交差点

交通量調査集計表(総流入出交通量)

③ 至 諸岡1丁目交差点

交差点名: 弓田交差点

調査日: 平成28年7月14日(木曜日)

時間帯	総 流 入 計									
	乗用車類		貨物車類		自動車 類計	小型車 計	大型車 計	大型車 混入率	バイク	自動車類計 時間比率
	乗用車	バス	小型貨物	普通貨物						
07:00~07:15	653	4	141	47	845	794	51	6.0	45	8.1
07:15~07:30	719	3	128	42	892	847	45	5.0	59	8.5
07:30~07:45	729	7	127	37	900	856	44	4.9	58	8.6
07:45~08:00	720	5	131	35	891	851	40	4.5	60	8.5
08:00~08:15	724	5	170	58	957	894	63	6.6	64	9.1
08:15~08:30	612	8	154	34	808	766	42	5.2	62	7.7
08:30~08:45	679	6	169	60	914	848	66	7.2	64	8.7
08:45~09:00	536	4	162	96	798	698	100	12.5	39	7.6
09:00~09:15	630	11	161	83	885	791	94	10.6	26	8.5
09:15~09:30	579	11	178	90	858	757	101	11.8	45	8.2
09:30~09:45	623	4	187	84	898	810	88	9.8	20	8.6
09:45~10:00	556	4	180	85	825	736	89	10.8	26	7.9
朝ピーク 3時間計	7,760	72	1,888	751	10,471	9,648	823	7.9	568	92.1
10:00~10:15	657	14	249	75	995	906	89	8.9	38	4.9
10:15~10:30	531	7	208	66	812	739	73	9.0	21	4.0
10:30~10:45	543	9	199	76	827	742	85	10.3	30	4.1
10:45~11:00	601	6	208	66	881	809	72	8.2	25	4.4
11:00~11:15	562	11	195	68	836	757	79	9.4	29	4.1
11:15~11:30	569	2	202	63	836	771	65	7.8	27	4.1
11:30~11:45	596	11	208	61	876	804	72	8.2	26	4.3
11:45~12:00	574	7	173	54	808	747	61	7.5	16	4.0
12:00~12:15	681	7	165	67	920	846	74	8.0	37	4.6
12:15~12:30	585	7	156	53	801	741	60	7.5	27	4.0
12:30~12:45	564	6	139	42	751	703	48	6.4	21	3.7
12:45~13:00	632	6	137	51	826	769	57	6.9	19	4.1
13:00~13:15	543	7	145	42	737	688	49	6.6	30	3.6
13:15~13:30	553	8	167	58	786	720	66	8.4	30	3.9
13:30~13:45	571	8	168	55	802	739	63	7.9	27	4.0
13:45~14:00	548	5	156	58	767	704	63	8.2	22	3.8
14:00~14:15	577	8	181	61	827	758	69	8.3	16	4.1
14:15~14:30	636	5	223	66	930	859	71	7.6	18	4.6
14:30~14:45	692	8	194	73	967	886	81	8.4	27	4.8
14:45~15:00	534	8	190	52	784	724	60	7.7	40	3.9
15:00~15:15	651	4	137	44	836	788	48	5.7	30	4.1
15:15~15:30	619	7	162	59	847	781	66	7.8	29	4.2
15:30~15:45	662	7	180	51	900	842	58	6.4	39	4.5
15:45~16:00	626	15	146	54	841	772	69	8.2	23	4.2
オフピーク 6時間計	14,307	183	4,288	1,415	20,193	18,595	1,598	7.9	647	95.8
16:00~16:15	624	7	194	39	864	818	46	5.3	27	7.8
16:15~16:30	627	7	163	33	830	790	40	4.8	28	7.5
16:30~16:45	572	9	161	27	769	733	36	4.7	29	7.0
16:45~17:00	678	9	191	38	916	869	47	5.1	28	8.3
17:00~17:15	688	8	177	42	915	865	50	5.5	37	8.3
17:15~17:30	706	6	202	36	950	908	42	4.4	63	8.6
17:30~17:45	737	4	182	32	955	919	36	3.8	61	8.6
17:45~18:00	845	6	157	41	1,049	1,002	47	4.5	55	9.5
18:00~18:15	862	4	159	28	1,053	1,021	32	3.0	56	9.5
18:15~18:30	732	8	127	23	890	859	31	3.5	51	8.0
18:30~18:45	804	2	123	19	948	927	21	2.2	65	8.6
18:45~19:00	757	7	131	23	918	888	30	3.3	59	8.3
夕ピーク 3時間計	8,632	77	1,967	381	11,057	10,599	458	4.1	559	91.7
12時間計	30,699	332	8,143	2,547	41,721	38,842	2,879	6.9	1,774	100

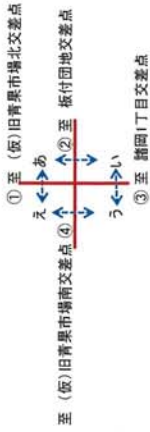

歩行者類交通量

交差点名：弓田交差点

調査日：#####

時間帯	あーい		いーう		うーえ		えーう		えーあ		あーえ		総利用者															
	歩行者	自転車	歩行者	自転車	歩行者	自転車	歩行者	自転車	歩行者	自転車	歩行者	自転車	歩行者	自転車	合計													
07:00~07:15	14	5	19	0	0	5	4	9	3	12	15	3	2	10	12	5	0	3	3	16	11	27						
07:15~07:30	7	15	22	2	1	3	6	8	1	13	14	1	2	1	10	11	2	2	4	6	13	22	35					
07:30~07:45	10	24	34	2	4	8	12	20	4	23	27	3	5	8	3	15	18	1	2	3	1	9	10	37	51			
07:45~08:00	36	24	60	2	6	10	22	32	11	26	37	8	3	11	9	22	31	6	15	21	3	10	13	47	55	102		
08:00~08:15	41	37	78	2	2	4	20	13	33	5	24	29	6	15	6	23	29	9	18	5	5	10	57	53	110			
08:15~08:30	4	21	25	1	2	3	11	21	32	10	32	42	5	4	9	16	22	2	9	11	5	12	17	12	44	56		
08:30~08:45	4	38	42	2	2	4	4	10	14	4	15	19	2	10	12	7	19	26	1	9	10	5	13	18	12	62	74	
08:45~09:00	1	17	18	1	9	10	8	13	21	4	17	21	5	6	11	6	13	19	0	10	10	0	5	5	2	41	43	
09:00~09:15	3	11	14	4	3	7	18	15	33	11	14	25	3	0	3	3	6	3	1	4	4	5	9	14	20	34		
09:15~09:30	0	12	12	2	4	6	7	8	15	1	7	8	6	3	9	2	5	7	1	5	6	1	4	5	4	25	29	
09:30~09:45	7	17	24	4	3	7	7	9	16	4	13	17	3	9	12	5	14	19	2	5	7	3	3	6	16	28	44	
09:45~10:00	7	11	18	0	5	5	8	8	16	7	9	16	4	6	10	2	7	9	2	5	7	3	5	8	12	26	38	
<b>朝ピーク 3時間計</b>	<b>134</b>	<b>232</b>	<b>366</b>	<b>22</b>	<b>39</b>	<b>61</b>	<b>112</b>	<b>137</b>	<b>249</b>	<b>65</b>	<b>205</b>	<b>270</b>	<b>49</b>	<b>56</b>	<b>105</b>	<b>157</b>	<b>209</b>	<b>31</b>	<b>75</b>	<b>106</b>	<b>32</b>	<b>78</b>	<b>110</b>	<b>219</b>	<b>424</b>	<b>643</b>		
10:00~10:15	2	8	10	5	10	15	11	8	19	1	12	13	1	2	4	4	8	1	3	4	2	10	12	10	31	41		
10:15~10:30	1	4	5	3	1	4	5	8	13	5	9	14	2	3	5	3	10	13	1	3	4	2	3	5	7	11	18	
10:30~10:45	4	9	13	7	8	15	4	8	12	2	9	11	4	12	16	3	3	6	2	1	3	6	5	11	19	23	42	
10:45~11:00	4	7	11	1	9	10	6	8	14	8	14	8	5	9	14	1	2	3	2	4	6	8	2	4	6	8	22	30
11:00~11:15	2	7	9	6	1	7	8	7	15	11	13	24	4	2	6	5	5	10	1	2	5	2	7	9	14	11	25	
11:15~11:30	1	7	8	1	6	7	6	13	19	5	7	12	3	4	7	4	3	7	0	7	7	2	7	9	4	27	31	
11:30~11:45	5	7	12	4	6	10	3	12	15	10	12	22	5	6	11	3	7	10	1	2	3	4	2	6	14	17	31	
11:45~12:00	2	5	7	2	4	6	8	10	18	5	9	14	5	8	13	5	3	8	3	2	5	3	3	6	10	14	24	
12:00~12:15	19	4	23	11	6	17	19	7	26	7	11	18	3	7	10	21	6	27	6	1	7	14	5	19	50	16	66	
12:15~12:30	2	6	8	6	2	8	6	9	15	12	7	19	1	4	5	5	4	9	6	4	10	5	2	7	19	14	33	
12:30~12:45	2	8	10	3	4	7	4	9	13	11	6	17	3	6	9	8	3	11	7	18	3	9	12	19	28	47		
12:45~13:00	4	4	8	13	2	15	14	4	18	11	14	25	10	2	12	3	4	7	8	7	15	5	1	6	30	14	44	
13:00~13:15	0	7	7	5	10	15	2	5	7	9	14	23	2	7	9	3	6	9	0	7	7	4	2	6	9	26	35	
13:15~13:30	0	7	7	6	10	16	1	5	6	8	16	0	8	8	2	1	3	1	4	5	2	3	5	9	24	33		
13:30~13:45	2	7	9	4	5	9	6	8	14	8	10	18	2	8	10	5	3	8	0	2	2	4	3	7	10	17	27	
13:45~14:00	2	1	3	9	3	12	7	4	11	8	7	15	4	4	8	4	8	12	0	4	4	4	2	6	15	10	25	
14:00~14:15	2	9	11	3	13	16	4	8	12	6	17	23	6	10	16	2	8	10	2	2	4	4	2	6	11	26	37	
14:15~14:30	3	5	8	2	9	11	3	4	7	6	12	2	5	7	1	5	6	3	3	6	3	6	3	6	9	11	23	34
14:30~14:45	3	8	11	7	6	13	2	5	7	8	6	14	2	3	5	1	3	4	4	4	8	1	3	4	15	21	36	
14:45~15:00	4	4	8	11	7	18	4	13	17	4	5	9	2	5	7	3	0	3	4	4	8	1	2	3	20	17	37	
15:00~15:15	6	8	14	6	4	10	2	6	8	3	7	10	1	2	3	2	2	4	1	3	4	4	1	5	17	16	33	
15:15~15:30	0	10	10	3	10	13	5	5	10	2	5	7	3	9	12	1	4	5	3	6	9	1	5	6	7	31	38	
15:30~15:45	6	4	10	32	12	44	6	6	12	5	10	15	0	7	7	2	6	8	5	3	8	1	12	13	44	31	75	
15:45~16:00	5	7	12	10	9	19	11	6	17	5	6	11	0	4	4	2	1	3	4	1	5	5	4	9	24	21	45	
<b>オフピーク 6時間計</b>	<b>81</b>	<b>153</b>	<b>234</b>	<b>160</b>	<b>157</b>	<b>317</b>	<b>147</b>	<b>178</b>	<b>325</b>	<b>160</b>	<b>215</b>	<b>375</b>	<b>70</b>	<b>136</b>	<b>206</b>	<b>93</b>	<b>101</b>	<b>194</b>	<b>68</b>	<b>83</b>	<b>151</b>	<b>87</b>	<b>98</b>	<b>185</b>	<b>396</b>	<b>491</b>	<b>887</b>	
16:00~16:15	2	4	6	3	3	6	21	8	29	1	6	7	3	13	16	2	2	4	2	1	3	3	1	4	10	9	19	
16:15~16:30	6	5	11	2	10	12	13	8	21	5	13	18	6	4	10	1	3	4	2	1	3	2	1	3	12	17	29	
16:30~16:45	0	3	3	4	6	10	17	11	28	6	5	11	2	3	0	6	6	0	2	2	0	1	1	4	12	16	29	
16:45~17:00	0	11	11	10	11	21	9	6	15	5	14	19	5	6	11	1	4	5	0	2	2	2	3	5	12	27	39	
17:00~17:15	5	7	12	4	18	22	5	10	15	15	7	22	5	14	19	8	2	10	0	1	1	0	15	15	9	41	50	
17:15~17:30	4	8	12	6	6	12	12	11	23	5	15	20	4	9	13	4	8	12	3	1	4	3	10	13	16	25	41	
17:30~17:45	3	12	15	5	18	23	5	15	20	12	29	41	5	14	19	9	11	20	2	2	4	1	5	6	11	37	48	
17:45~18:00	5	9	14	8	26	34	8	16	24	4	20	24	3	16	19	2	5	7	0	4	4	4	8	12	17	47	64	
18:00~18:15	5	7	12	13	21	34	8	20	28	4	9	13	12	16	28	0	13	3	9	12	2	8	10	23	45	68		
18:15~18:30	6	16	22	7	20	27	7	17	24	6	12	18	6	11	17	4	6	10	4	2	6	4	9	13	21	47	68	
18:30~18:45	2	9	11	7	24	31	7	10	17	3	13	16	2	18	20	2	12	14	1	7	8	5	8	13	15	48	63	
18:45~19:00	1	6	7	11	16	27	16	18	34	4	12	16	7	18	25	1	3	4	0	4	6	8	14	18	34	52		
<b>夕ピーク 3時間計</b>	<b>39</b>	<b>97</b>	<b>136</b>	<b>80</b>	<b>179</b>	<b>259</b>	<b>128</b>	<b>150</b>	<b>278</b>	<b>70</b>	<b>155</b>	<b>225</b>	<b>59</b>	<b>141</b>	<b>200</b>	<b>34</b>	<b>75</b>	<b>109</b>	<b>17</b>	<b>36</b>	<b>53</b>	<b>32</b>	<b>77</b>	<b>109</b>	<b>168</b>	<b>389</b>	<b>557</b>	
<b>12時間計</b>	<b>254</b>	<b>482</b>	<b>736</b>	<b>262</b>	<b>375</b>	<b>637</b>	<b>387</b>	<b>465</b>	<b>852</b>	<b>295</b>	<b></b>																	



弓田交差点  
H28.7.14(木)

自動車類計  
【12時間(7:00~19:00)】  
数字:交通量(台/12H  
( )内:大型車混入率(%)

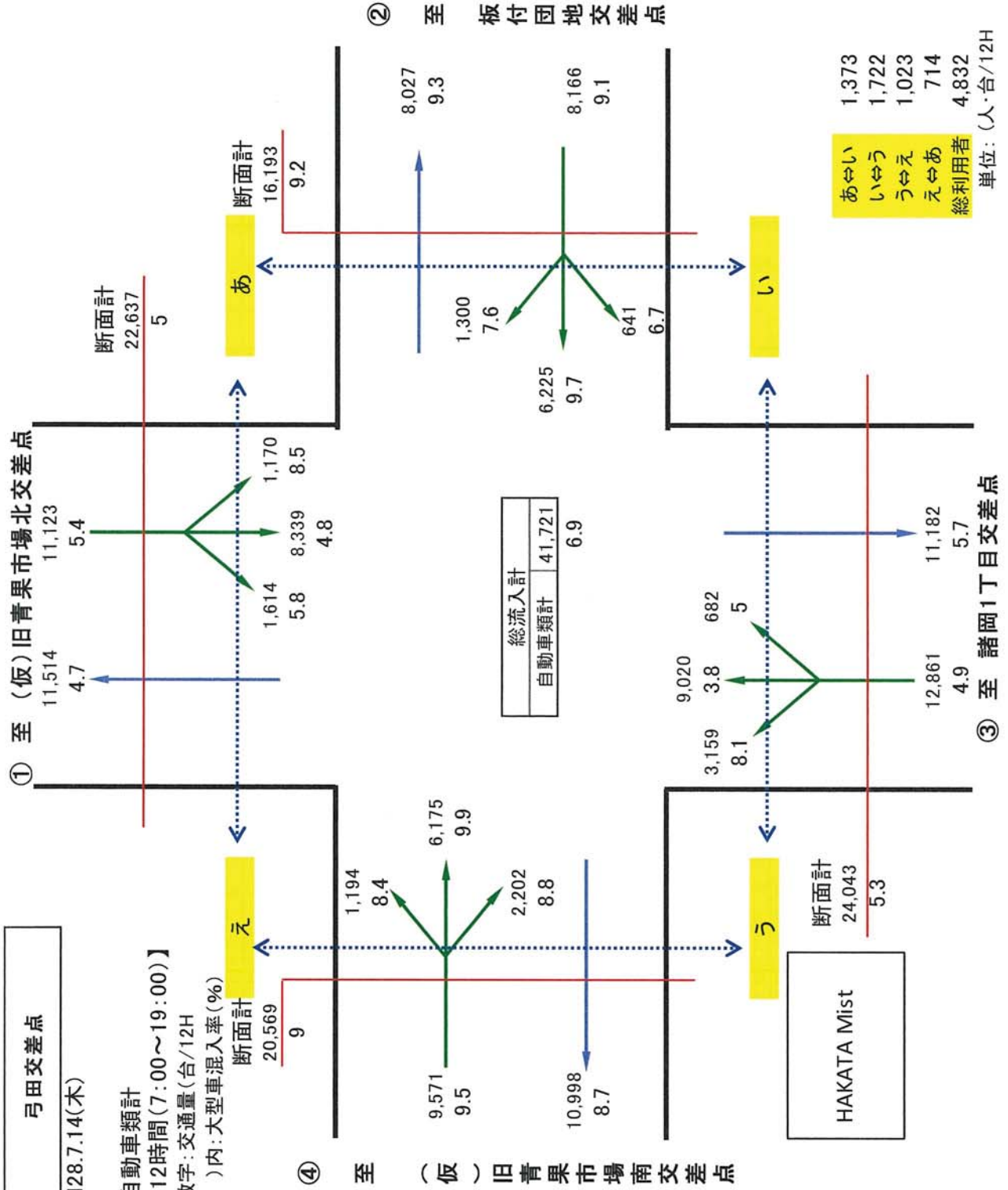

流入部別交通量

交差点名: 弓田交差点

調査日: H28.07.14(木)

総流入交通量

時間帯	小型車 交通量	大型車 交通量	大型車 混入率
7	3348	180	5.1%
8	3206	271	7.8%
9	3094	372	10.7%
10	3196	319	9.1%
11	3079	277	8.3%
12	3059	239	7.2%
13	2851	241	7.8%
14	3227	281	8.0%
15	3183	241	7.0%
16	3210	169	5.0%
17	3694	175	4.5%
18	3695	114	3.0%
12時間計	38842	2879	6.9%

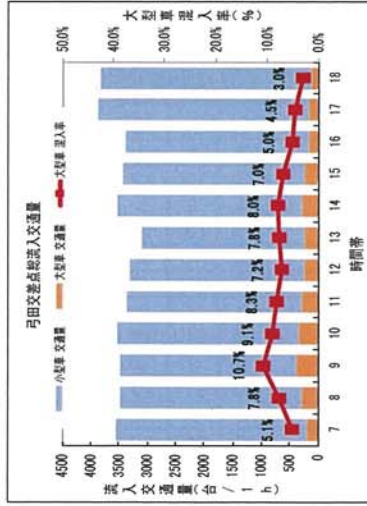

弓田交差点

車種	台数	構成比
乗用車	30,699	68.8%
バス	332	0.7%
小型貨物	8,143	18.3%
普通貨物	2,547	5.7%
大型車計	2,879	6.5%
自動車計	44,600	100.0%

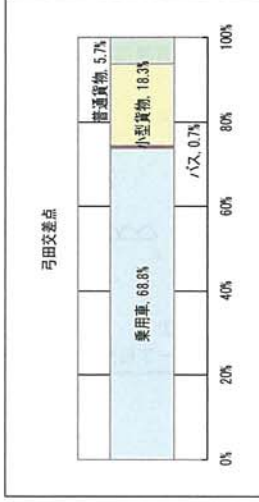

流入部①: 至 (仮)旧青森市境北交差点

時間帯	小型車 交通量	大型車 交通量	大型車 混入率
7	533	32	5.7%
8	716	55	7.1%
9	808	78	8.8%
10	836	66	7.3%
11	930	60	6.1%
12	929	40	4.1%
13	829	53	6.0%
14	943	66	6.5%
15	937	51	5.2%
16	830	26	3.0%
17	1069	42	3.8%
18	1166	28	2.3%
12時間計	10526	597	5.4%

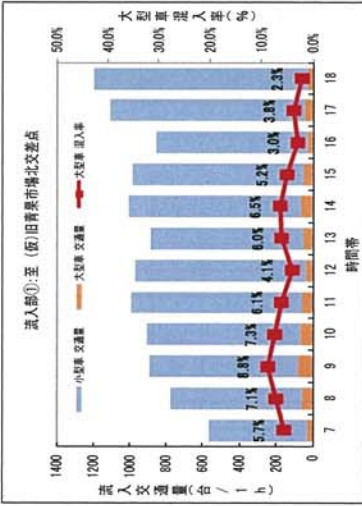

流入部③: 至 諸岡丁交差点

時間帯	小型車 交通量	大型車 交通量	大型車 混入率
7	1413	38	2.6%
8	1131	68	5.7%
9	1005	73	6.8%
10	962	73	7.1%
11	895	58	6.2%
12	932	48	4.9%
13	888	50	5.3%
14	971	50	4.9%
15	967	61	5.9%
16	989	41	4.0%
17	1009	36	3.4%
18	1075	32	2.9%
12時間計	12233	628	4.9%

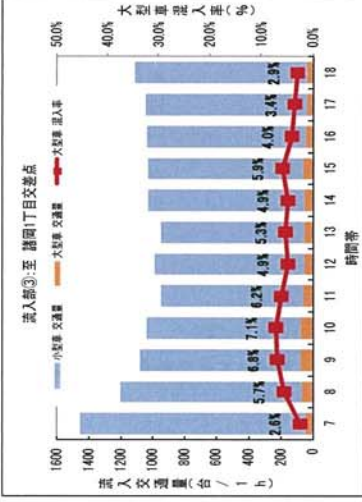

流入部②: 至 板付団地交差点

時間帯	小型車 交通量	大型車 交通量	大型車 混入率
7	556	56	9.2%
8	609	85	12.2%
9	609	112	15.5%
10	603	62	9.3%
11	550	65	10.6%
12	503	62	11.0%
13	452	67	12.9%
14	615	83	11.9%
15	653	54	7.6%
16	730	47	6.0%
17	817	34	4.0%
18	722	20	2.7%
12時間計	7419	747	9.1%

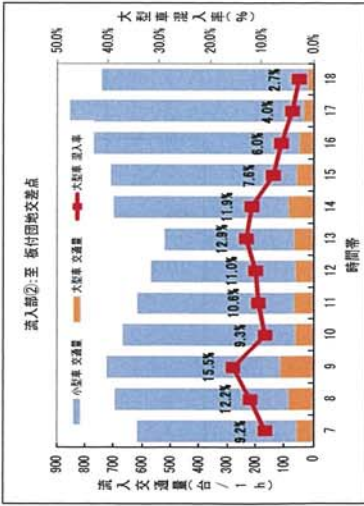

流入部④: 至 (仮)旧青森市境南交差点

時間帯	小型車 交通量	大型車 交通量	大型車 混入率
7	846	54	6.0%
8	750	63	7.7%
9	672	109	14.0%
10	795	118	12.9%
11	714	94	11.6%
12	695	89	11.4%
13	682	71	9.4%
14	692	82	10.6%
15	626	75	10.7%
16	661	55	7.7%
17	799	63	7.3%
18	732	34	4.4%
12時間計	8664	907	9.5%

