

第3回交通安全部会

付 属 資 料

Aルート ②地点

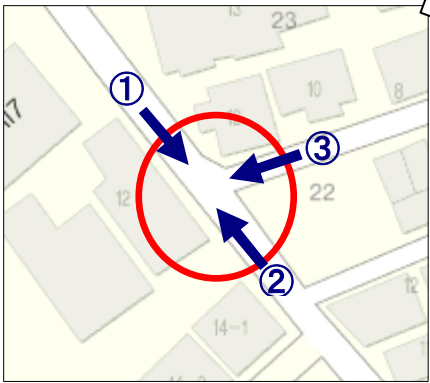
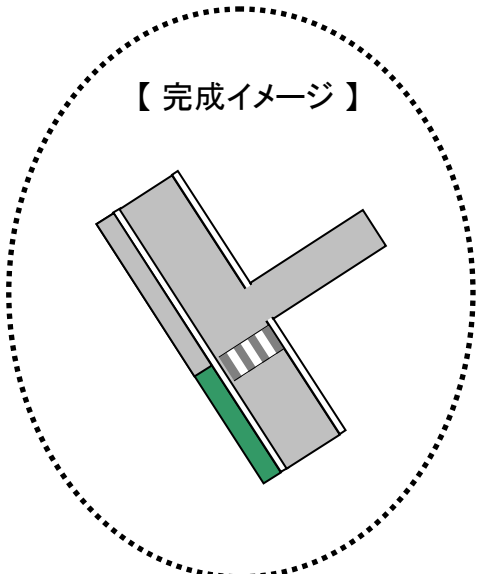
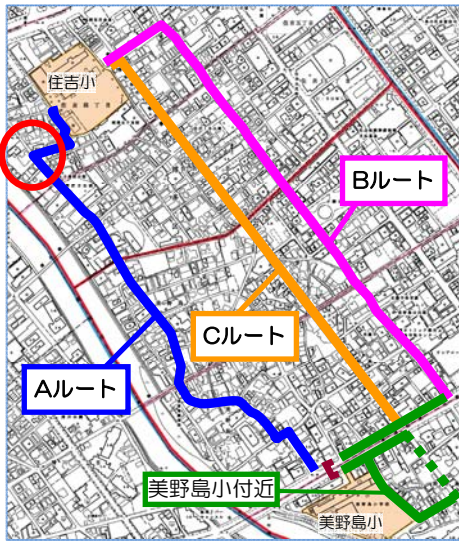

横断歩道の新設

Aルート ④地点

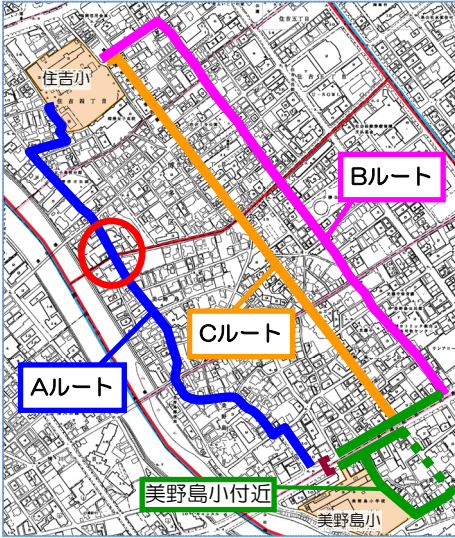

【完成イメージ】

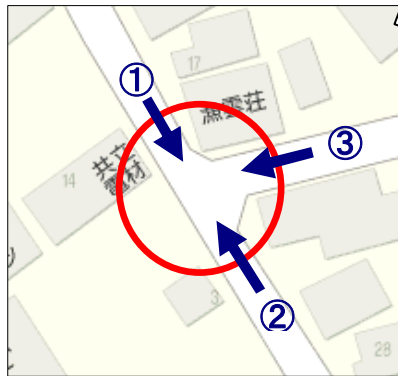
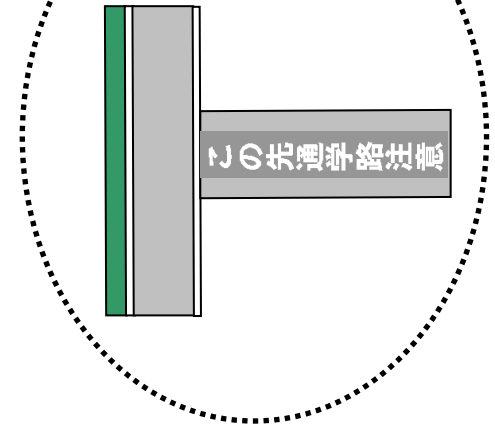

注意喚起標示(対自動車)



Aルート ⑤地点

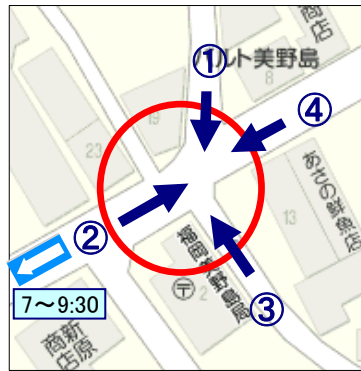
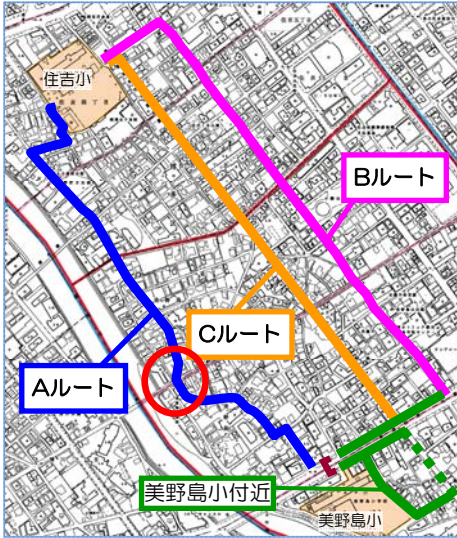

- 横断歩道の再塗装
- 違反車両の取締り(一方通行)



Bルート ②地点

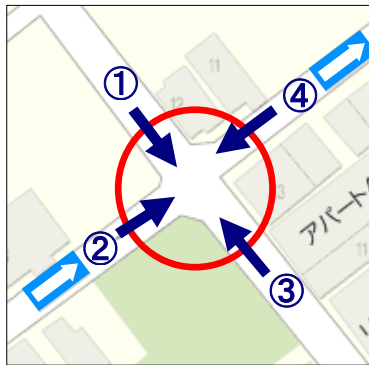
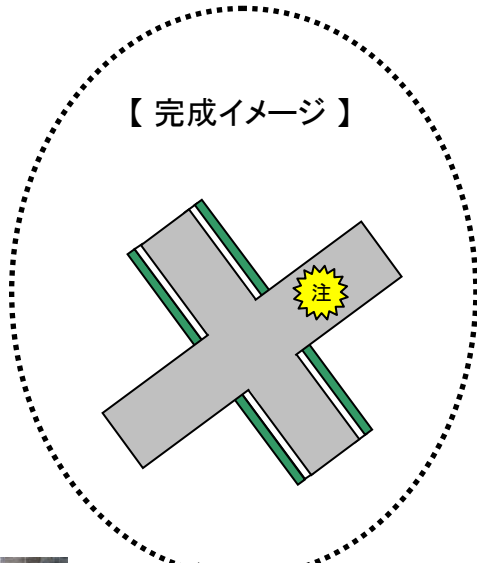
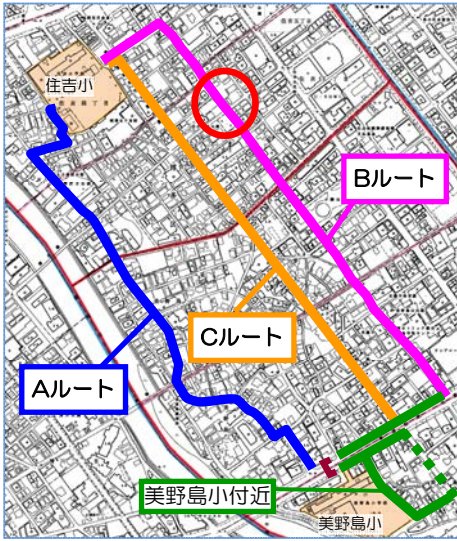

注意喚起標示(対自転車)



Bルート ③地点

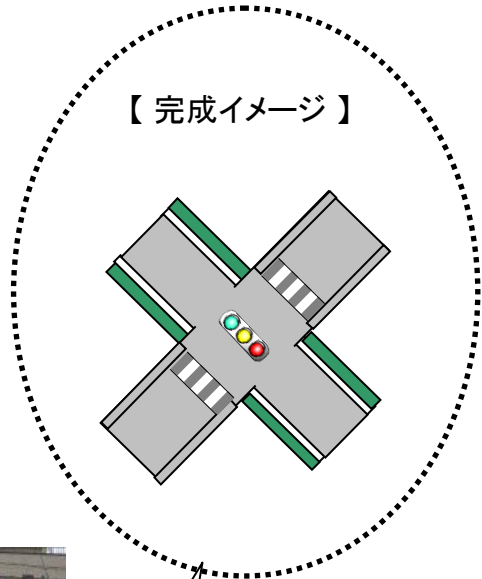
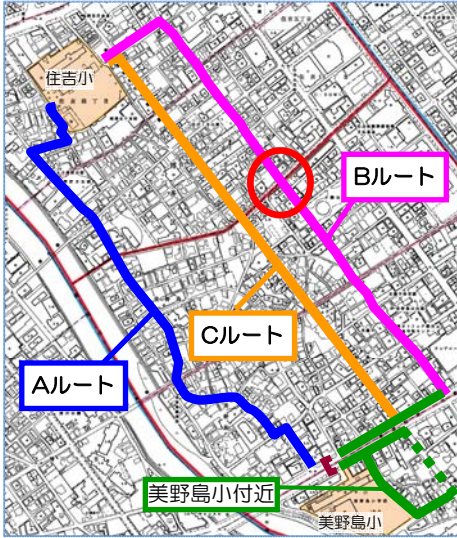

横断歩道の新設

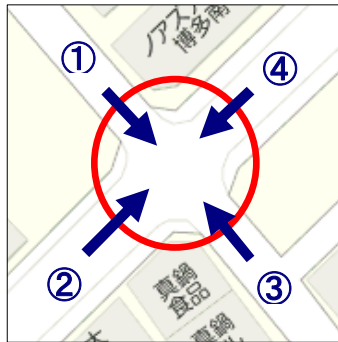

横断歩道の新設



信号機の変更
(点滅式→押しボタン式)

Bルート ④地点

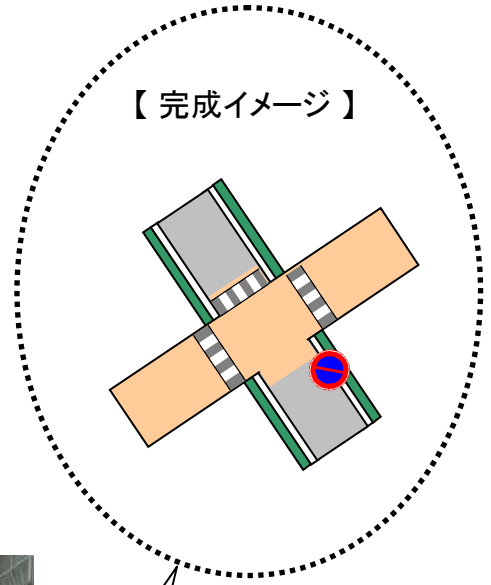
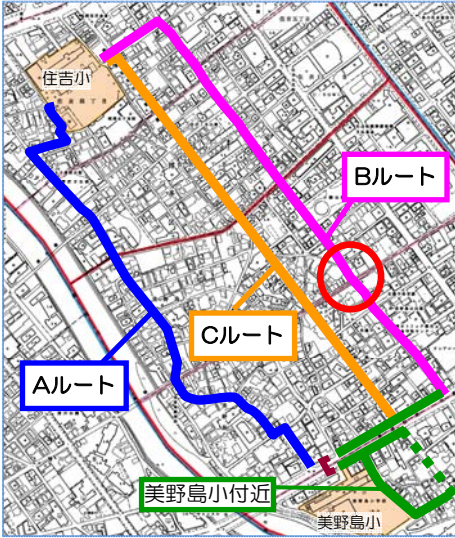

横断歩道の新設

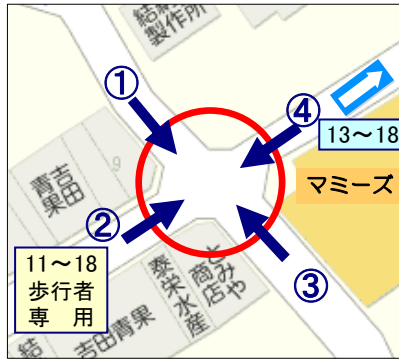

駐車禁止の標示

Bルート ⑤地点

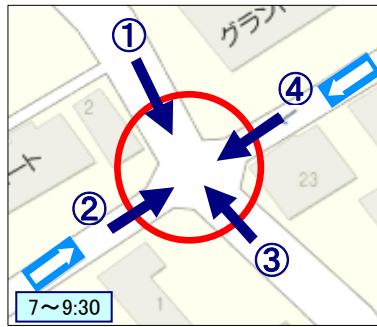
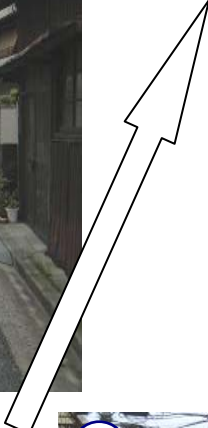
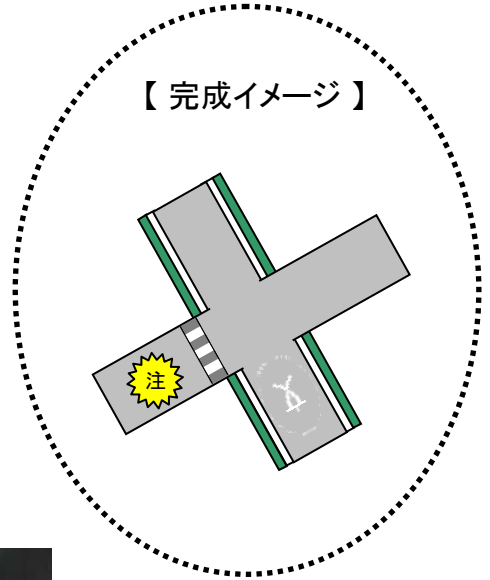
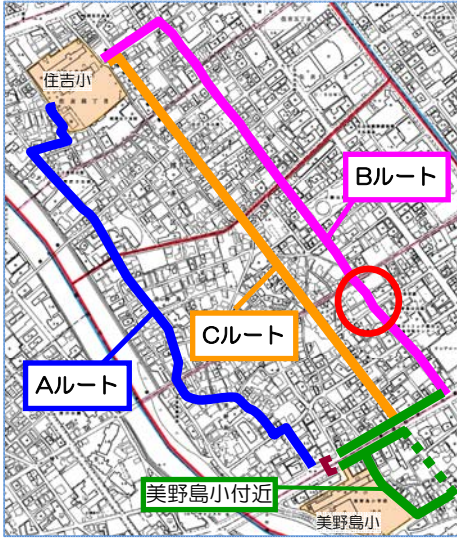

○注意喚起標示(対自転車)
○横断歩道の新設



Bルート ⑥地点

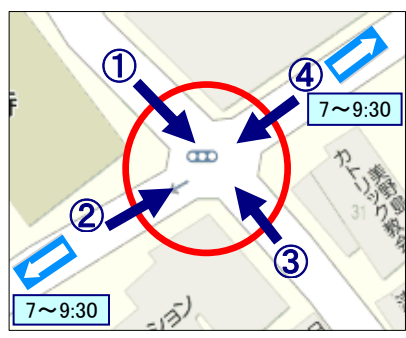
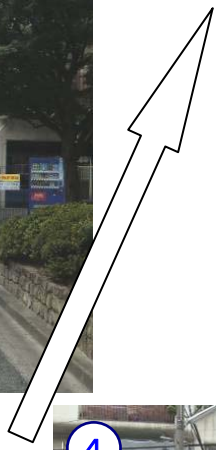
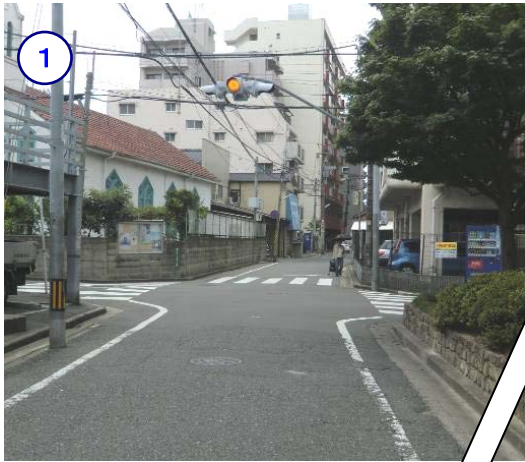
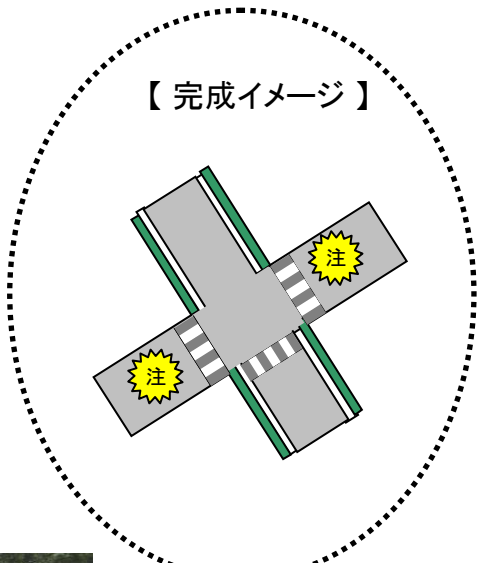
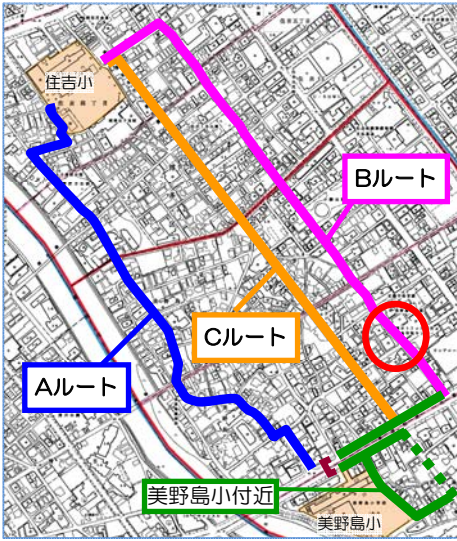

○注意喚起標示(対自転車)
○違反車両の取締り(一方通行)

○注意喚起標示(対自転車)
○違反車両の取締り(一方通行)



Cルート ①地点

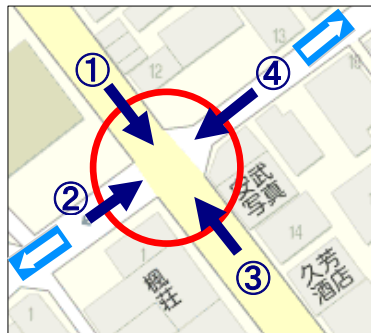
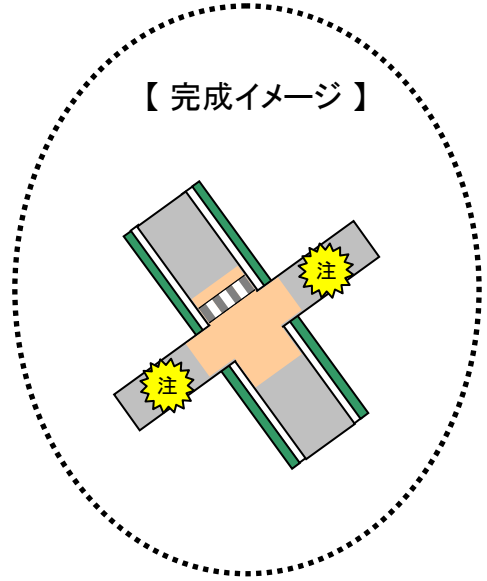
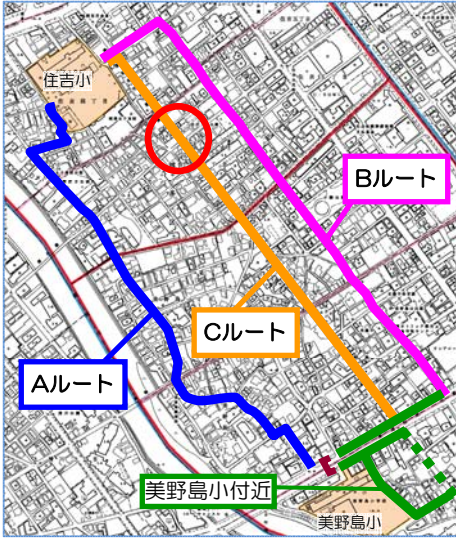

注意喚起標示(対自転車)

注意喚起標示(対自転車)



交差点のカラー塗装

Cルート ②地点

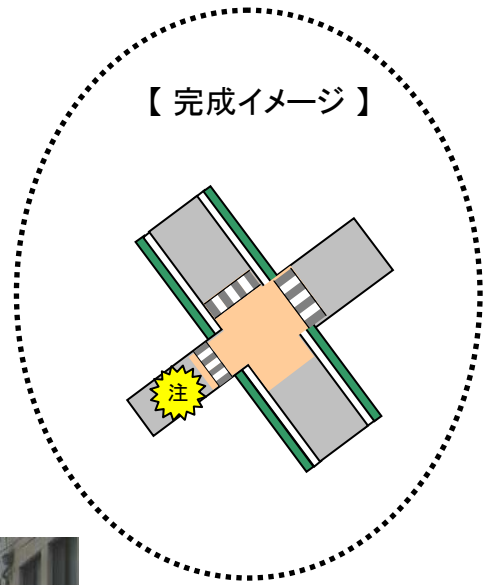
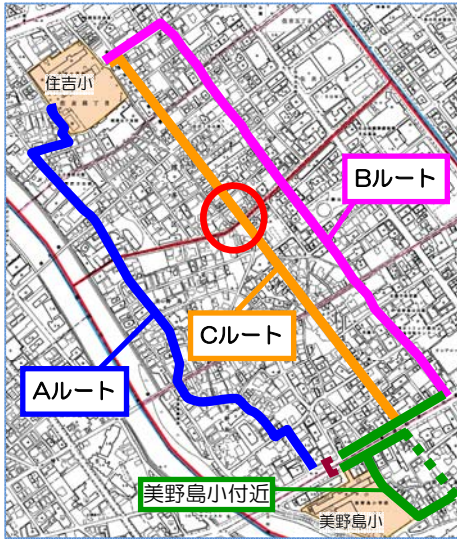

○注意喚起標示(対自転車)
○横断歩道の新設



交差点のカラー塗装

Cルート ③地点

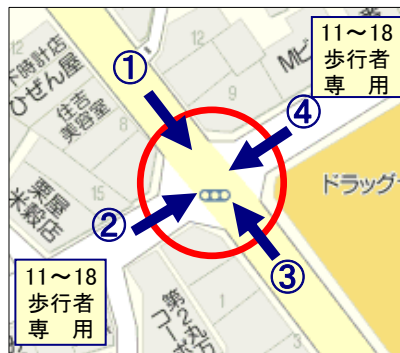
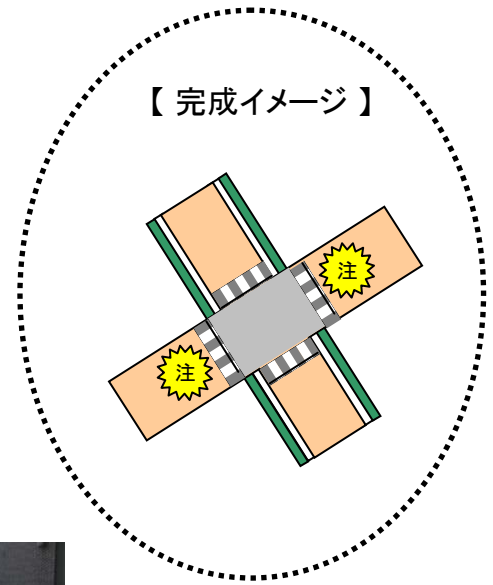
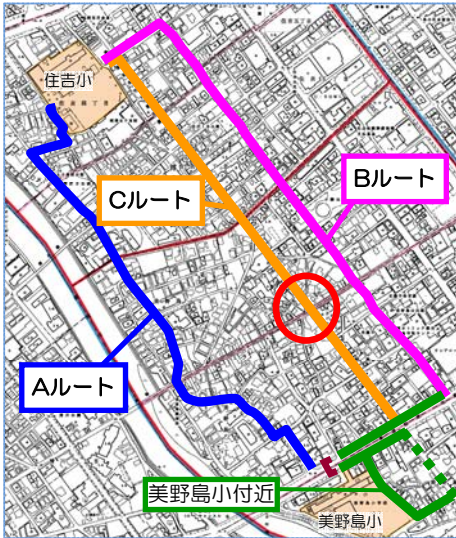

- 注意喚起標示(対自転車)
- 横断歩道の新設

- 注意喚起標示(対自転車)
- 横断歩道の再塗装

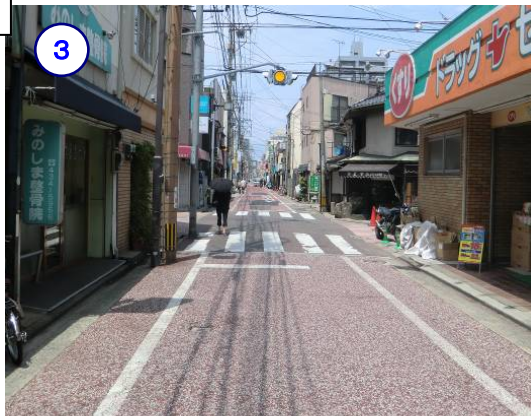

Cルート ④地点

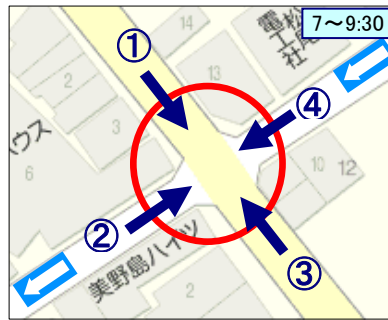
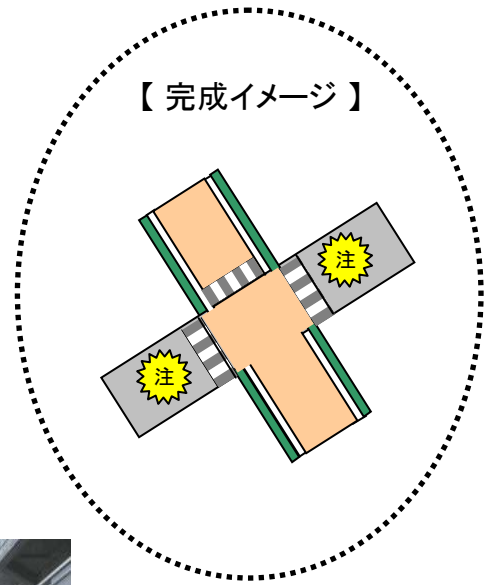
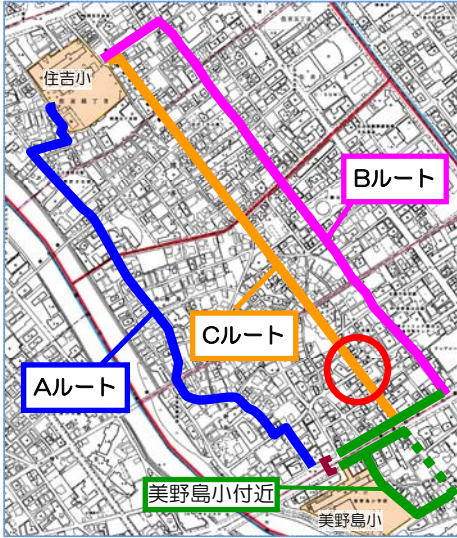

注意喚起標示(対自転車)

注意喚起標示(対自転車)

